

Owner's Manual**Main features**

- **Provides numerous vocal effects for the guitarist**
 - HARMONY automatically adds harmony to your vocal, based on your guitar playing
 - VOCODER uses your voice to add expressive power to your guitar performance
 - ENHANCE improves the clarity of your sound
 - PITCH CORRECT corrects inaccuracies in pitch
 - Four independent general-purpose FX units provide 20 distinctive effect types such as DISTORTION and RADIO, and there are also two independent REVERB/DELAY units, giving you a high degree of flexibility for making effect settings
- **Panel layout that provides high functionality and emphasizes live performance, with an easily readable screen display and an independent [HARMONY] switch**
- **Memory function lets you store and recall 99 setups in internal memory**
- **By connecting a USB cable or MIDI cable, you can synchronize the unit with an external MIDI device or a DAW on your computer, or switch sounds and control parameters**

 **Owner's Manual** (this document)

Read this first. It explains the basic things you need to know in order to use the VE-500. For detailed information on how to operate the VE-500, please download and refer to "Parameter Guide" (PDF file).

 **PDF Manual** (download from the Web)

- **Parameter Guide**

This explains all of the parameters of the VE-500.

 **To obtain the PDF manual**

- 1. Enter the following URL on your computer.**
<http://www.boss.info/manuals/>
▼
- 2. Choose "VE-500" as the product name.**

Before using this unit, carefully read "USING THE UNIT SAFELY" and "IMPORTANT NOTES" (the leaflet "USING THE UNIT SAFELY" and the Owner's Manual (p. 20)). After reading, keep the document(s) where it will be available for immediate reference.

Contents

Getting Ready	3	System Settings (MENU)	16
Connecting the Equipment	3	Basic Operation	16
Connecting the Equipment	4	Adjusting the Display Contrast	17
Top Panel	5	Enabling/Disabling the Auto-Off Function	17
Screen Structure	6	Returning to the Factory Settings (Factory Reset)	17
Operation of the [1]–[3] Knobs	7		
Switching Pages	7	Synchronizing with a DAW or External MIDI Device	18
Turning On/Off the Power	8	Installing the USB Driver	18
Tuning (Tuner)	8	Installing the Dedicated Software	18
Playing	9		
Mic Settings	9	Appendix	19
Adjusting the Mic Sensitivity ...	9	Error Messages	19
Phantom Power Settings	9	Attaching the Rubber Feet	19
Patch Structure	9	Main Specifications	19
Switching Between Memory and Manual Modes	9		
Switching Patches	10	USING THE UNIT SAFELY	20
Adding a Harmony Effect	10		
About the Play Screen	10	IMPORTANT NOTES	20
Editing a Patch	11		
Basic Operation	11		
Changing the Effect Connections	12		
Changing the CTL & ASSIGN Settings	13		
Matching the Harmony to the Key of the Song	14		
Saving a Patch (Write)	15		
Exchanging Patches	15		
Initializing a Patch	15		

* To prevent malfunction and equipment failure, always turn down the volume, and turn off all the units before making any connections.

* The power to this unit will be turned off automatically after a predetermined amount of time has passed since it was last used for playing music, or its buttons or controls were operated (Auto Off function). If you do not want the power to be turned off automatically, disengage the Auto Off function ("Enabling/Disabling the Auto-Off Function" (p. 17)).

- Any settings that you are in the process of editing will be lost when the power is turned off. If you have any settings that you want to keep, you should save them beforehand.
- To restore power, turn the power on again (p. 8).

Getting Ready

Connecting the Equipment

INST INPUT jack

Connect your electric guitar or other instrument here. HARMONY or VOCODER effects are applied to your vocal according to your guitar playing.



MIC IN connector

Connect your mic here. If you connect a condenser mic, turn phantom power on as described in "Phantom Power Settings" (p. 9). The VE-500 is equipped with a balanced (XLR) connector.



MIDI IN connector

Connect an external MIDI device here. The VE-500 can receive program change messages, and synchronize its tempo with a MIDI device.



(MICRO USB) port

Use a micro USB cable to connect your computer here. This allows MIDI and audio signals to be exchanged.

* Do not use a micro USB cable that is designed only for charging a device. Charge-only cables cannot transmit data.

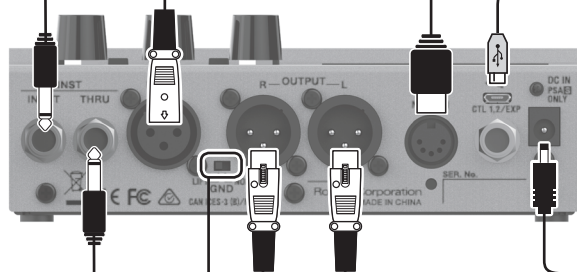

INST THRU jack



Connect your guitar amp or effect unit here.

* The signal that enters the INST INPUT jack is output from here.

OUTPUT L, R connectors



Connect these connectors to your PA mixer, etc. These connectors output the signal processed by the effects. The VE-500 is equipped with balanced (XLR) connectors.

* The sound of the guitar is not output.

DC IN jack



Connect the AC adaptor here.

* Use only the included AC adaptor (PSA-S series), and make sure that the AC outlet is the correct voltage for the adaptor.

[GND LIFT] switch

In some cases, you might hear "ground loop hum" (a buzz or hum) when the VE-500 is connected to an external device. If this occurs, changing the setting of the [GND LIFT] switch might lessen the problem. Normally you'll leave this switch in the NOR (NORMAL) position.

Switch	Explanation
NOR	Pin 1 of the OUTPUT jacks is connected to the VE-500's GND.
LIFT	Pin 1 of the OUTPUT jacks is disconnected from the VE-500's GND.

OUTPUT connector pin configuration

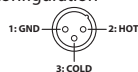

Getting Ready

Connecting the Equipment

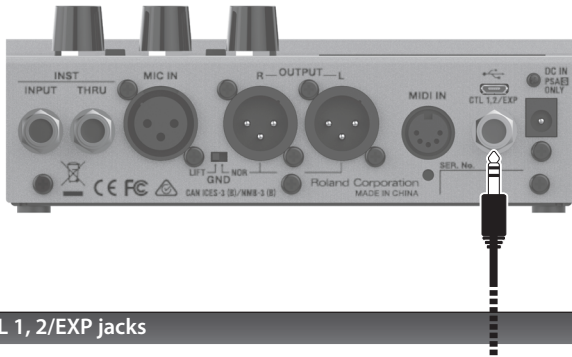

CTL 1, 2 / EXP jack pin configuration

TIP: HOT
RING: COLD
SLEEVE: GND

CTL 1, 2/EXP jacks

You can control various parameters by connecting a footswitch (FS-5U, FS-5L, FS-6, FS-7: sold separately) or an expression pedal (such as the FV-500H, FV-500L, EV-30, Roland EV-5: sold separately) to the CTL 1, 2/EXP jack (p. 13)

When Connecting an FS-5U (or FS-5L)

1/4" phone type
↔ 1/4" phone type

CTL 1

When connecting an FS-5L, set MODE of CTL IN1 / CTL IN2 to "MOMENT" (p. 13).

POLARITY switch

When Connecting Two FS-5Us (or FS-5Ls)

Stereo 1/4" phone type
↔ 1/4" phone type x 2

CTL 2 CTL 1

When Connecting an FS-6

Stereo 1/4" phone type
↔ Stereo 1/4" phone type

CTL 2 CTL 1

When Connecting an FS-7

Stereo 1/4" phone type
↔ Stereo 1/4" phone type

When connecting expression pedal

* Use only the specified expression pedal (FV-500H, FV-500L, EV-30, Roland EV-5; sold separately). By connecting any other expression pedals, you risk causing malfunction and/or damage to the unit.

EXP

MODE/POLARITY switch

POLARITY MODE
FS-5U (MOMENTARY) FS-5L (LATCH)

MODE/POLARITY switch

POLARITY MODE
FS-6 (MOMENTARY) FS-7 (LATCH)

Top Panel

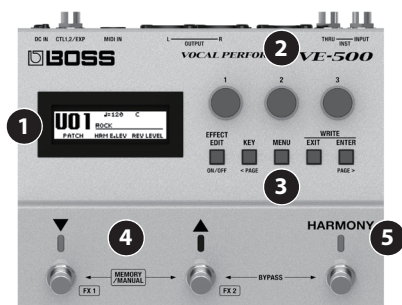

1	Display This shows various information for the VE-500.
	[1]–[3] knob Select and edit the parameter values shown in the display.
2	<ul style="list-style-type: none"> * Refer to “Operation of the [1]–[3] Knobs” (p. 7) * If the lock function is on, the [1]–[3] knobs are disabled in the play screen (p. 10) to prevent unintended operation. For more about the lock function, refer to “Parameter Guide” (PDF).
	[EFFECT EDIT] ([ON/OFF]) button Makes patch settings. When editing, this button turns on/off the selected effect.
3	[KEY] ([< PAGE]) button Specifies the key of the harmony. <ul style="list-style-type: none"> • In screens that show page tabs, use this as the [< PAGE] button to switch pages.
	[MENU] button Lets you make system settings.

[EXIT] button

Cancels an operation or returns to the previous screen.

3 **[ENTER] ([PAGE >]) button**

Press this to confirm an operation.

- In screens that show page tabs, use this as the [PAGE >] button to switch pages.
- In the play screen, use this to switch the display.

[▼][▲] switch

4 In memory mode, use these switches to select patches. In manual mode, use these switches to operate the assigned function (with the factory settings, these turn FX1 and FX2 on/off).

[HARMONY] switch

Turns harmony on/off.

- 5**
- Press the [▲] and [HARMONY] switches simultaneously to bypass the effect.
 - Long-press the [▲] and [HARMONY] switches simultaneously to access the tuner screen.

The function of each switch can be freely assigned in “CTL & ASSIGN SETTING” (p. 13). The color of the indicator changes depending on the specified function.

Getting Ready

Screen Structure

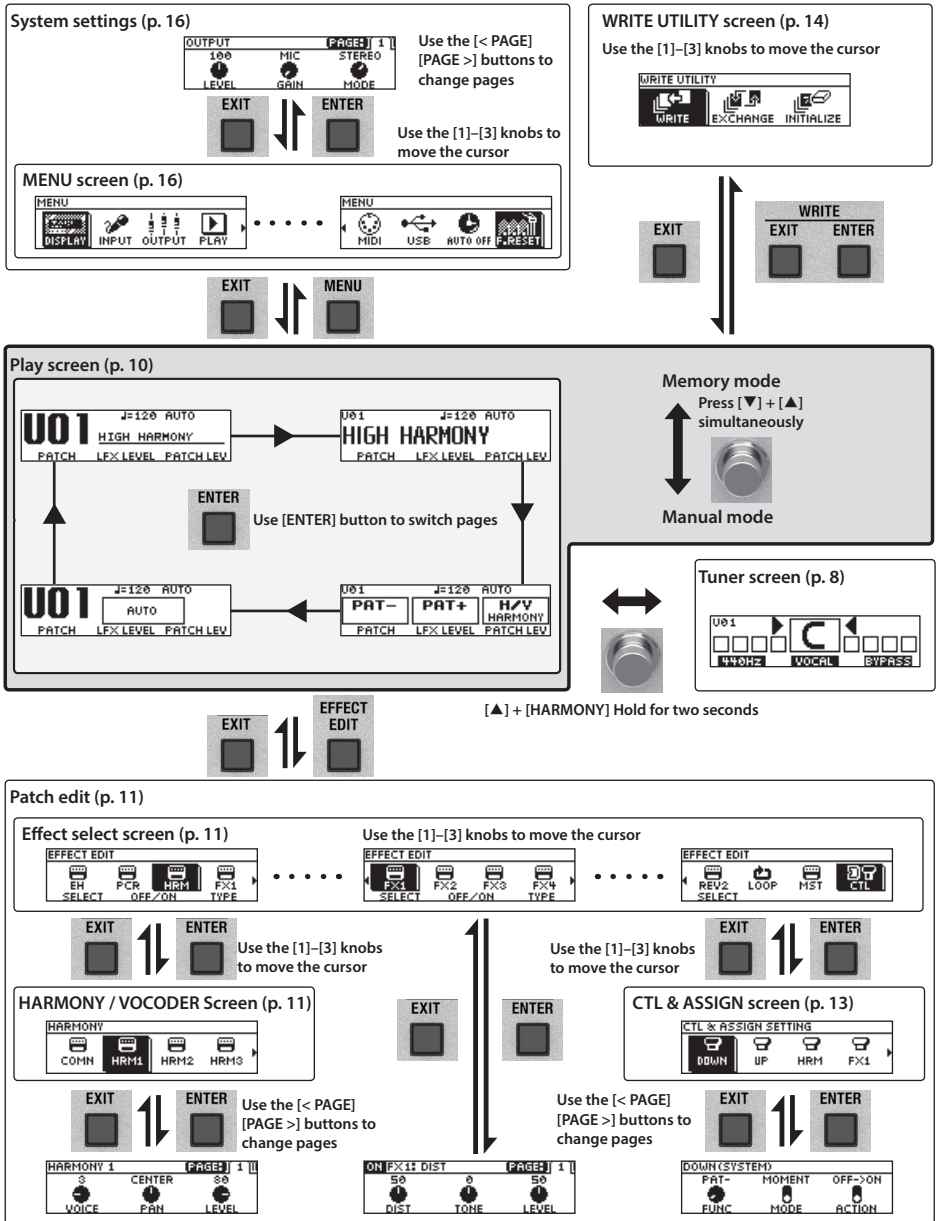

Operation of the [1]–[3] Knobs

- In the play screen (p. 10), the [1]–[3] knobs correspond to the functions that are assigned by “System settings” -> “KNOB” (p. 16).

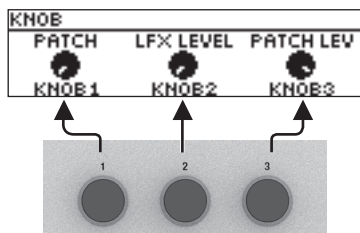

- In the effect select screen (p. 11), the [1]–[3] knobs have the following functions.

[1] knob	[2] knob	[3] knob
Move cursor	Turn effect on/off	Select effect type

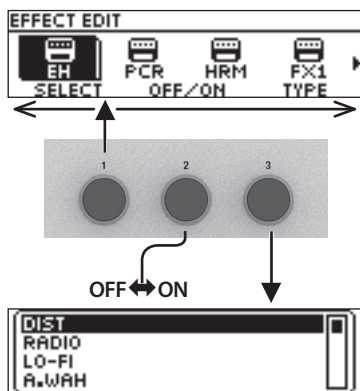

- In the CTL & ASSIGN screen (p. 13), WRITE UTILITY screen (p. 15), and MENU screen (p. 16), you can move the cursor and select an icon by operating any knob.

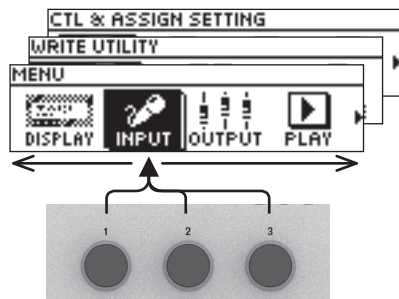

- In screens where knob or switch icons are shown, the [1]–[3] knobs correspond to those icons.

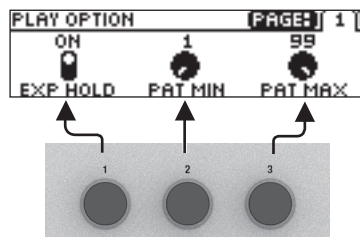

Switching Pages

- When page tabs are displayed on the screen, you can switch pages by pressing the [< PAGE] [PAGE >] buttons.

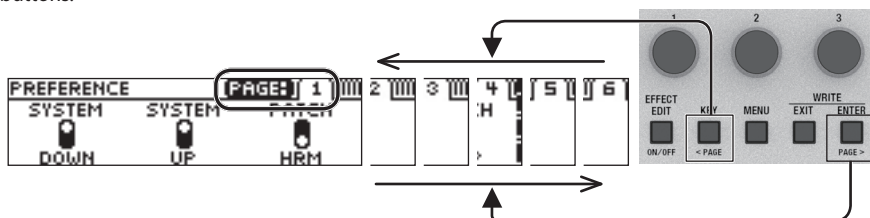

Getting Ready

Turning On/Off the Power

The DC IN jack also functions as the power switch. The power turns on when you insert the AC adaptor's plug into the DC IN jack, and turns off when you disconnect it.

- * Before turning the unit on/off, always be sure to turn the volume down. Even with the volume turned down, you might hear some sound when switching the unit on/off. However, this is normal and does not indicate a malfunction.
- * Before you make connections, make sure that the input gain or volume of your mixer, recorder or amplifier is turned down.

To turn the power on

Power-on in the following order: this unit (plug in the AC adaptor) → connected devices → amp.

To turn the power off

Power-off in the following order: amp → connected devices → this unit (unplug the AC adaptor).

Tuning (Tuner)

1. Simultaneously long-press (two seconds or longer) the [▲] switch and [HARMONY] switch.

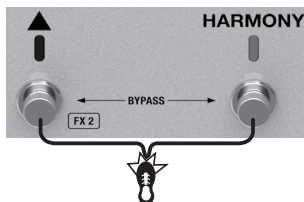

The tuner screen appears.



2. Play your guitar or input your voice, and tune your instrument. Tune so that only the indicator in the center of the screen is lit.



3. When you finish tuning, once again long-press the [▲] switch and [HARMONY] switch simultaneously.

Specifying the reference pitch

Turn knob [1] to change the tuner's reference pitch.

- * Changing the tuner's reference pitch also changes the reference pitch for the harmony.

PITCH

435–445 Hz (default: 440 Hz)

Tuner Source

Turn knob [2] to select the input signal that is detected by the tuner.

SOURCE	Explanation
MIC	Tune the mic
INST	Tune the guitar
INST&M	Tune both guitar and mic

Output settings

Turn knob [3] to specify how the vocal sound is output while you're using the tuner.

VOCAL OUT	Explanation
BYPASS	Output with the effects off
DRY	Output with ENHANCE applied
LEAD	Output with ENHANCE and PITCH CORRECT applied
MUTE	Output is muted

Playing

Mic Settings

Adjusting the Mic Sensitivity

1. Press the [MENU] button.



2. Use the [1] knob to select "INPUT," and then press the [ENTER] button.
3. Use knob [1] to adjust the sensitivity of the mic.

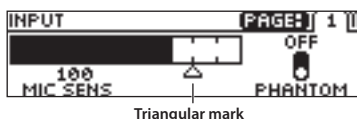

Triangular mark

Adjust the mic sensitivity appropriately while watching the level meter in the screen.

- * The appropriate sensitivity is when the loudest input sound reaches the approximate position of the triangular mark.

MIC SENS

0–200 (default: 100)

Phantom Power Settings

4. If you're using a condenser mic, use knob [3] to turn "PHANTOM" on.

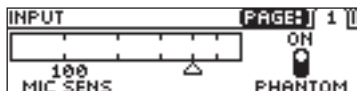

PHANTOM	Explanation
OFF	Phantom power off
ON	Phantom power on

5. Press the [EXIT] button a number of times to return to the play screen.

Patch Structure

A combination of VE-500 effects and settings for those effects is called a "patch."

You can edit the settings of a patch and store it as a "user patch."

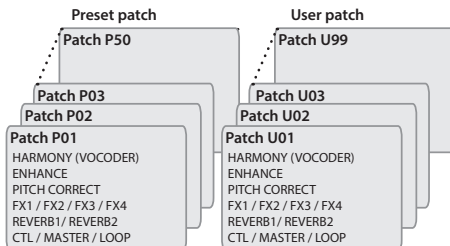

Switching Between Memory and Manual Modes

Memory mode

In this mode you can recall and use patches that are saved in the VE-500's memory. Use the [▼] and [▲] switches to select a patch.

Manual mode

In this mode you can operate the functions that are assigned to the [▼] and [▲] switches.

1. Press the [▼] switch and [▲] switch simultaneously.

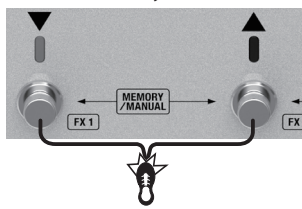

Each time you press these, you alternate between memory mode and manual mode.

Switching Patches

1. Switch to memory mode.
2. Use the [▼] [▲] switches to select a patch.

Pressing [▼] selects the previous patch number, and pressing [▲] selects the next patch number.

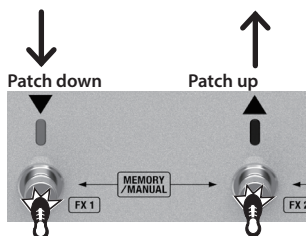

You can turn knob [1] to select patches consecutively.



- * You can't switch patches unless you're in the Play screen (next item). Press the [EXIT] button to return to the Play screen, and then switch patches.

Adding a Harmony Effect

1. Press the [HARMONY] switch to make the indicator light.

A harmony effect is applied.

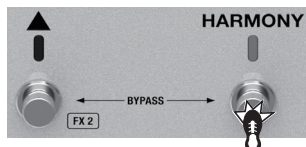

Try singing while you play your guitar, and notice the harmony effect.

- * A function other than turning the harmony effect on/off can also be assigned to the [HARMONY] switch (p. 13).

About the Play Screen

The screen that appears after you turn on the power is called the "Play screen."

Press the [ENTER] button to switch the display.

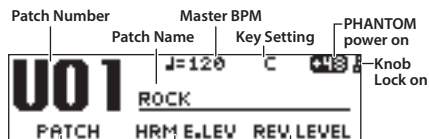

Parameters edited by the three knobs

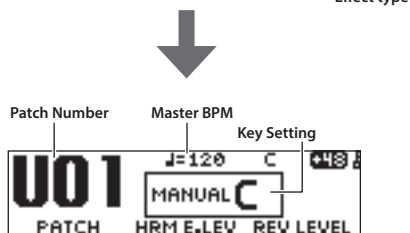
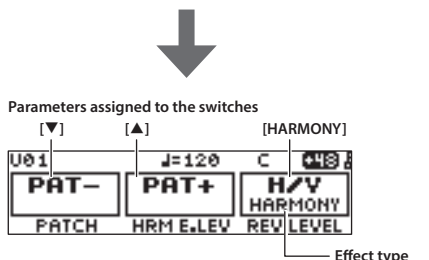
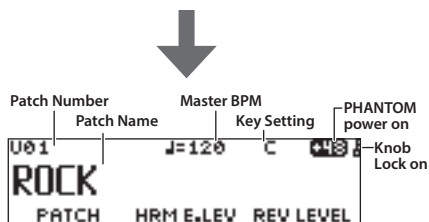

Editing a Patch

Basic Operation

1. Recall the patch that you want to edit (p. 10).
2. Press the [EFFECT EDIT] button.



The effect select screen appears.



3. Use knob [1] to select the effect that you want to edit.



You can use the [EFFECT EDIT] ([ON/OFF]) button or knob [2] to turn on/off the effect where the cursor is located (highlighted).



An effect that is on is shown by an icon. An effect that is off is shown as "OFF".

For details on the parameter, refer to the "Parameter Guide" (PDF file).

Effect	Explanation
EH	Improves the clarity of the sound.
PCR	Corrects inaccuracies in pitch. This is available only when HRM (harmony) is selected.
HRM	HRM: Adds harmony to your vocal.
VOC	VOC: A vocoder effect.
FX1	These let you select a variety of effect types. You can also choose the same effect for FX1–FX4.
FX4	
REV1	These let you select reverb or delay.
REV2	
LOOP	Overdub-record additional sound, and play it back as a loop.
MST	Adjust the tonal character of patches, and make other settings.
CTL	Refer to "Changing the CTL/ASSIGN Settings" (p. 13).

MEMO

For FX1–4, and HRM (VOC), you can use knob [3] to choose the effect type.



4. Press the [ENTER] button to access the edit screen.

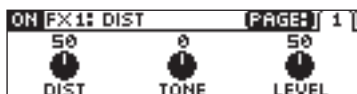

MEMO

In the edit screen, press the [ON/OFF] button to turn the effect on/off. This lets you hear what the effect does.

Editing a Patch

In screens where page tabs are displayed, use the [< PAGE] [PAGE >] buttons to move between editing screen pages.



- Use knobs [1]–[3] to specify the value of each parameter shown in the screen.

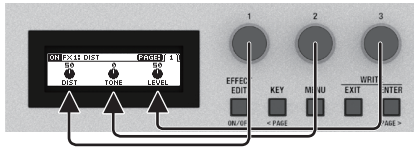

- Press the [EXIT] button a number of times to return to the play screen.

Changing the Effect Connections

- In the effect select screen, choose “MST.”



- Use “FX STRUCTURE” to change the order in which FX1–FX4 are connected.
- Use “REVERB STRUCTURE” to change the order in which REV1 and REV2 are connected.

The effect connection changes.

FX STRUCTURE

STRUCTURE1: SERIES

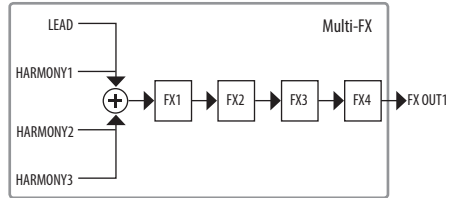

STRUCTURE2: PARA+SER

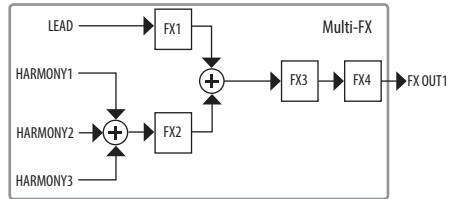

STRUCTURE3: 2PARALLEL

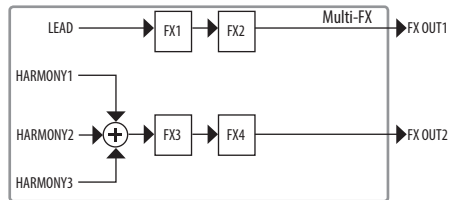

STRUCTURE4: 4PARALLEL

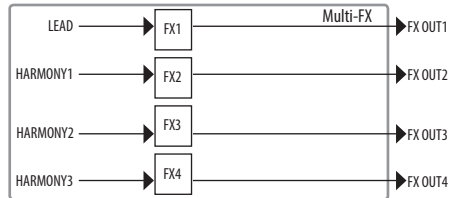

Output	Explanation
LEAD	Output the sound with ENHANCE and PITCH CORRECT applied
HARMONY1	Output the harmony sound
HARMONY2	Output the harmony sound
HARMONY3	Output the harmony sound

REVERB STRUCTURE

STRUCTURE1: SERIES

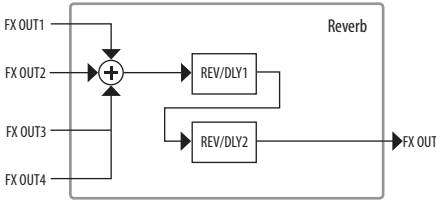

STRUCTURE2: PARALLEL

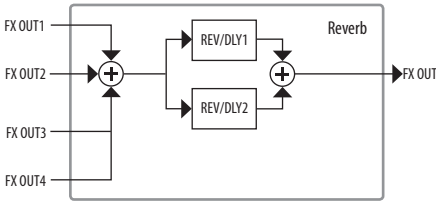

STRUCTURE3: SEPARATE

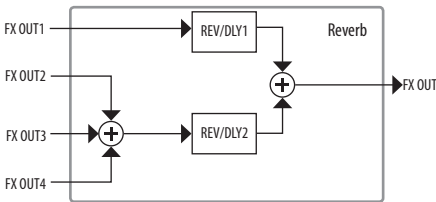

Changing the CTL & ASSIGN Settings

You can operate a variety of parameters by making CTL and ASSIGN settings for each patch.

1. In the effect select screen, use knobs [1]–[3] to select “CTL,” and then press the [ENTER] button.

The CTL & ASSIGN screen appears.

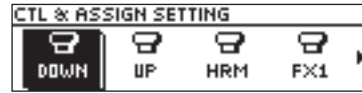

2. Use knobs [1]–[3] to select the controller that you want to edit.

An icon indicates controllers that are turned on. Controllers that are off are indicated by “OFF.”

Controller	Explanation
	Specifies the parameter that is controlled by the [▼] and [▲] switches when in Memory mode. * This works only in Memory mode.
	Specifies the parameter that is controlled by the [▼] ([FX1]) and [▲] ([FX2]) switches when in Manual mode. * This works only in Manual mode.
	Specifies the parameter that is controlled by the [HARMONY] switch.
	Specifies the parameter that is controlled by an expression pedal (EXP) connected to the CTL 1, 2/ EXP jack.
	Specifies the parameter that is controlled by a footswitch (CTL 1–2) connected to the CTL 1, 2/ EXP jack.
	Specifies the parameter that is controlled by pressing the [▼] and [▲] switches simultaneously.
	Specifies the parameter that is controlled by pressing the [▲] and [HARMONY] switches simultaneously.

English

日本語

Deutsch

Français





Italiano

Español

Português

Nederlands

Editing a Patch

Controller	Explanation
 ASSIGN 1  ASSIGN 2  ASSIGN 3	ASSIGN allows you to make more detailed settings. For example, you can use ASSIGN if you want to simultaneously control another parameter in addition to operating the parameter of the [▼] switch. You can specify eight different settings for each patch.
 ASSIGN COMMON	Make common settings for "ASSIGN."

- Press the [ENTER] button to move to the edit screen.



In screens that show page tabs, use the [< PAGE] [PAGE >] buttons to switch between edit screen pages.

- Use knobs [1]–[3] to edit the parameter values in the screen.

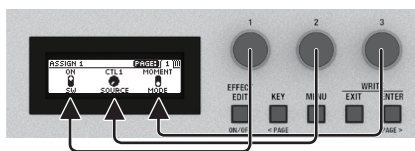

- Press the [EXIT] button a number of times to return to the play screen.

Matching the Harmony to the Key of the Song

- Press the [KEY] button.

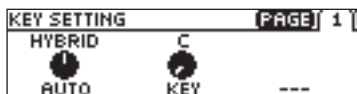

- Use knob [1] to specify the "AUTO" setting.

If Auto is set to "FULL" or "HYBRID," the key is specified automatically according to the chords and the chord progression that you play on the connected guitar.

AUTO	Explanation
FULL	Harmony is added according to the chords and the chord progression that you play on your guitar.
HYBRID	Harmony is added according to the "KEY" setting and the chords that you play on your guitar.
OFF	Harmony is added according to the "KEY" setting.

- * Try the FULL setting, and if you don't get the harmony that you expect, use the HYBRID setting. If you're not using a guitar, turn this OFF and specify the key.

- Use knob [2] to specify the "KEY."

- * As shown in the illustration below, specify the key of the song that you're singing. (Example) If you're singing a song in A minor, set the key to the relative key of "C."

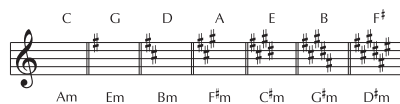

- Press the [EXIT] button a number of times to return to the play screen.

You can also add harmony according to note data that's input via the MIDI IN connector.

Saving a Patch (Write)

If you want to save the patch that you created, execute the Write operation.

- * You can use dedicated software to save, exchange, initialize, or back up patches (p. 18).

NOTE

- If you do not save the patch, the edited settings will be lost when you turn off the power or switch to another patch.
- When you save, the patch that had been in the save-destination is overwritten.

1. Press the [EXIT] button and [ENTER] button simultaneously.



The WRITE UTILITY screen appears.



2. Select "WRITE" and then press the [ENTER] button.
3. Choose the patch write destination (U01–U99) with the [1] knob, and press the [ENTER] button.



Here you can edit the name.

Controller	Operation
[1] knob	Changes the character
[2] knob	Moves the cursor
[3] knob	Selects the type of characters
[EFFECT EDIT] button	Delete the character at the cursor location
[MENU] button	Insert a space at the cursor location

4. To save the patch, press the [ENTER] button.

- * If you decide to cancel, press the [EXIT] button. Once the patch has been saved, you are returned to the Play screen.

Exchanging Patches

Here's how to exchange the currently selected patch with a patch that you specify.

1. In the WRITE UTILITY screen, select "EXCHANGE" and press the [ENTER] button.
2. Choose the exchange-destination patch with the [1] knob.



3. To exchange the patches, press the [ENTER] button.

- * If you decide to cancel, press the [EXIT] button. Once the patches has been exchanged, you are returned to the Play screen.

Initializing a Patch

Here's how to return the selected patch to the default values.

1. In the WRITE UTILITY screen, select "INITIALIZE" and press the [ENTER] button.
2. Choose the initialize-destination patch with the [1] knob.

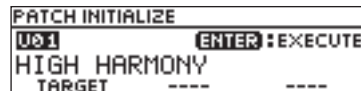

3. To initialize the patch, press the [ENTER] button.

- * If you decide to cancel, press the [EXIT] button. Once the patch has been initialized, you are returned to the Play screen.

System Settings (MENU)

Settings that are shared by the entire VE-500 are called “system settings.”

For details on the parameter, refer to the “Parameter Guide” (PDF file).

Basic Operation

1. Press the [MENU] button.



The MENU screen appears.



2. Choose the item that you want to edit.

Item	Explanation
	Adjust the contrast of the display.
	Make input-related settings.
	Make output-related settings.
	Make settings for the option functions during performance.
	Specify the functions of knobs [1]–[3] operated in the play screen.
	External pedals, and other settings will have independent settings for each patch or will share the same settings for all patches.
	This is the tuner screen.
	Make MIDI-related settings.
	Make USB-related settings.
	Refer to “Enabling/Disabling the Auto-Off Function” (p. 17).

Item	Explanation
	Refer to “Restoring the Factory Default Settings (Factory Reset)” (p. 17).

3. Press the [ENTER] button to enter the edit screen.

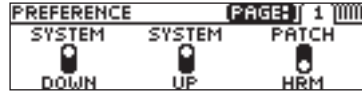

When page tabs are displayed on the screen, you can switch pages by pressing the [<PAGE>] [PAGE>] buttons.

4. Use the [1]–[3] knobs to edit the value of the parameters shown in the screen.

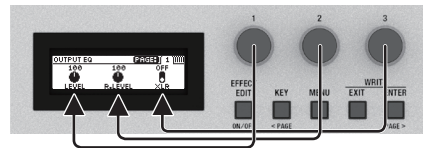

5. Press the [EXIT] button a number of times to return to the play screen.

* There is no Write function for the system settings. When you specify a parameter setting, the change is saved and applied automatically.

Adjusting the Display Contrast

You can adjust the brightness of the display.

- 1. In the MENU screen, select “DISPLAY” and press the [ENTER] button.**
- 2. Adjust the contrast with the [1] knob.**



Enabling/Disabling the Auto-Off Function

If you set the auto-off function to “On,” the power will turn off automatically when 10 hours have passed since you last played or operated the unit. The display will show a message approximately 15 minutes before the power turns off.

- * With the factory settings, this is turned “on.” If you don’t need the power to turn off automatically, turn this “off.”
- * If the power was turned off by the Auto Off function, disconnect and then reconnect the AC adaptor to turn the power on again.

- 1. In the MENU screen, select “AUTO OFF” and press the [ENTER] button.**
- 2. Set the On (AUTO OFF) or OFF with the [1] knob.**



Returning to the Factory Settings (Factory Reset)

Restoring the VE-500’s settings to their original factory default settings is referred to as “Factory Reset.”

Not only can you return all of the settings to the values in effect when the VE-500 was shipped from the factory, you can also specify the items to be reset.

- * When you execute “Factory Reset,” the settings you made will be lost. Save the data you need to your computer using the dedicated software.

- 1. In the MENU screen, choose “F. RST” and press the [ENTER] button.**
- 2. Choose the type of settings to be restored to the factory default settings with knobs [1] and [3].**



Parameter	Value	Explanation
[1] knob		
FROM	SYSTEM	System parameter settings
	U01–U99	Settings for Patch Numbers U01–U50
[3] knob		
TO	SYSTEM	System parameter settings
	U01–U99	Settings for Patch Numbers U01–U50

- 3. Press the [ENTER] button.**
 - 4. To execute the factory reset, use the knob to select “OK,” and press the [ENTER] button.**
- * If you decide not to execute the factory reset, select “CANCEL” and press the [ENTER] button.

Once the Factory Reset is complete, you are returned to the Play screen.

Synchronizing with a DAW or External MIDI Device

By transmitting and receiving MIDI messages, the VE-500 can synchronize with a computer or an external MIDI device. For example, you can switch VE-500 patches from an external MIDI device or DAW, or match the tempo.

If the VE-500 is connected via USB to a computer, you can also use dedicated software to do the following.

- Edit patch settings.
- Rename patches.
- Change the order of patches, or replace them.
- Back up patches and internal settings, or restore the backed-up settings.
- View the “Parameter Guide” and “MIDI Implementation Chart” (PDF).

Connection example

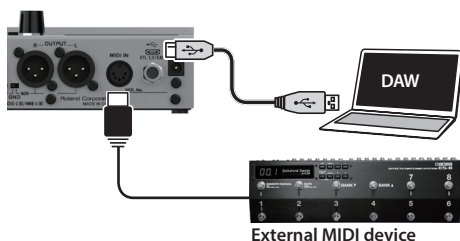

MIDI messages that can be transmitted and received

Patch change

Bank select (CC#0, #32) and program change

Synchronization data

Tempo clock (F8)

Patch data

System Exclusive messages

Other messages

Note (receiving only)

Control changes

- * Control change transmission and reception are specified by the ASSIGN settings. In addition to receiving control changes, the VE-500 can also transmit them when you operate a switch or the EXP pedal.

For details on the parameter, refer to the “Parameter Guide” (PDF file).

Installing the USB Driver

You must install the USB driver before connecting to a computer.

Please download the USB driver from the BOSS website.

Install this special driver before making a USB connection.

Download the USB driver from the BOSS website. For details, refer to Readme.htm which is included in the download.

➔ <https://www.boss.info/support/>

The program you need to use, and the steps you need to take to install the USB driver will differ depending on your computer setup, so please carefully read and refer to the Readme.htm file that comes with the download.

Installing the Dedicated Software

You can easily download dedicated software from the BOSS website.

➔ <https://www.boss.info/support/>

For details on how to use the software, refer to the Readme.htm file that comes with the download.

Appendix

Error Messages

Display	Problem	Action
SENDING BULK DATA	Currently transmitting a MIDI bulk dump.	-
RECEIVING BULK DATA	Currently receiving a MIDI bulk dump.	-
MIDI OFFLINE	Communication from the connected device has been interrupted. This message is also displayed if the connected device is powered-off. This is not a malfunction.	Check whether the connection cable might be disconnected or broken.
MIDI BUFFER FULL	An excessive amount of MIDI data was received in a short time from an external MIDI device connected to the MIDI IN connector, and the VE-500 was unable to process it.	Reduce the amount of MIDI data that is being sent to the VE-500.
USB CONNECTED	The USB cable is connected.	-
USB DISCONNECTED	Communication from the connected device has been interrupted. This message is also displayed if the connected device is powered-off. This is not a malfunction.	Check whether the connection cable might be disconnected or broken.
KNOB IS LOCKED	The buttons and knobs are locked.	Turn off the lock function.
MEMORY DAMAGED!	User memory is damaged.	Execute the factory reset operation (p. 17). If this does not solve the problem, a malfunction might have occurred. Consult the nearest Roland service center.

Attaching the Rubber Feet

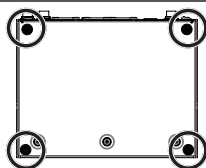

You can attach the rubber feet (included) if necessary.

- * When turning the unit over, be careful so as to protect the buttons and knobs from damage. Also, handle the unit carefully; do not drop it.
- * Attach the rubber feet correctly. If they are not attached correctly, they could deform or malfunction.

Main Specifications

BOSS VE-500: Vocal Performer

Power Supply	AC Adaptor	
Current Draw	310 mA (with phantom power)	210 mA (without phantom power)
Dimensions	170 (W) x 138 (D) x 62 (H) mm 6-3/4 (W) x 5-7/16 (D) x 2-1/2 (H) inches	
Weight	860 g	1 lb 15 oz
Display	Graphic LCD (132 x 32 dots, backlit LCD)	
Accessories	AC adaptor: PSA series, Owner's manual, Leaflet "USING THE UNIT SAFELY," Rubber Feet x 4	
Options (sold separately)	Footswitch: FS-5U, FS-5L Dual Footswitch: FS-6, FS-7 Expression Pedal: FV-500H, FV-500L, EV-30, Roland EV-5	

* 0 dBu = 0.775 Vrms

* This document explains the specifications of the product at the time that the document was issued. For the latest information, refer to the Roland website.

USING THE UNIT SAFELY

WARNING

Concerning the Auto Off function

The power to this unit will be turned off automatically after a predetermined amount of time has passed since it was last used for playing music, or its buttons or controls were operated (Auto Off function). If you do not want the power to be turned off automatically, disengage the Auto Off function (p. 17).



Use only the supplied AC adaptor and the correct voltage

Be sure to use only the AC adaptor supplied with the unit. Also, make sure the line voltage at the installation matches the input voltage specified on the AC adaptor's body. Other AC adaptors may use a different polarity, or be designed for a different voltage, so their use could result in damage, malfunction, or electric shock.



CAUTION

Keep small items out of the reach of children

To prevent accidental ingestion of the parts listed below, always keep them out of the reach of small children.

- Accessories
Rubber Feet (p. 19)



CAUTION

Precautions concerning use of phantom power supply

Always turn the phantom power off when connecting any device other than condenser microphones that require phantom power. You risk causing damage if you mistakenly supply phantom power to dynamic microphones, audio playback devices, or other devices that don't require such power. Be sure to check the specifications of any microphone you intend to use by referring to the manual that came with it.



(This instrument's phantom power: 48 V DC, 10 mA Max)

IMPORTANT NOTES

Placement

- Depending on the material and temperature of the surface on which you place the unit, its rubber feet may discolor or mar the surface.

Repairs and Data

- Before sending the unit away for repairs, be sure to make a backup of the data stored within it; or you may prefer to write down the needed information. Although we will do our utmost to preserve the data stored in your unit when we carry out repairs, in some cases, such as when the memory section is physically damaged, restoration of the stored content may be impossible. Roland assumes no liability concerning the restoration of any stored content that has been lost.

Additional Precautions

- Any data stored within the unit can be lost as the result of equipment failure, incorrect operation, etc. To protect yourself against the irretrievable loss of data, try to make a habit of creating regular backups of the data you've stored in the unit.
- Roland assumes no liability concerning the restoration of any stored content that has been lost.
- Never strike or apply strong pressure to the display.

- Use only the specified expression pedal. By connecting any other expression pedals, you risk causing malfunction and/or damage to the unit.
- Do not use connection cables that contain a built-in resistor.

Licenses/Trademarks

- ASIO is a trademark and software of Steinberg Media Technologies GmbH.
- This product contains eParts integrated software platform of eSOL Co., Ltd. eParts is a trademark of eSOL Co., Ltd. in Japan.
- Roland and BOSS are either registered trademarks or trademarks of Roland Corporation in the United States and/or other countries.
- Company names and product names appearing in this document are registered trademarks or trademarks of their respective owners.